

# Link

Architecture on the ceiling

VIBIA®

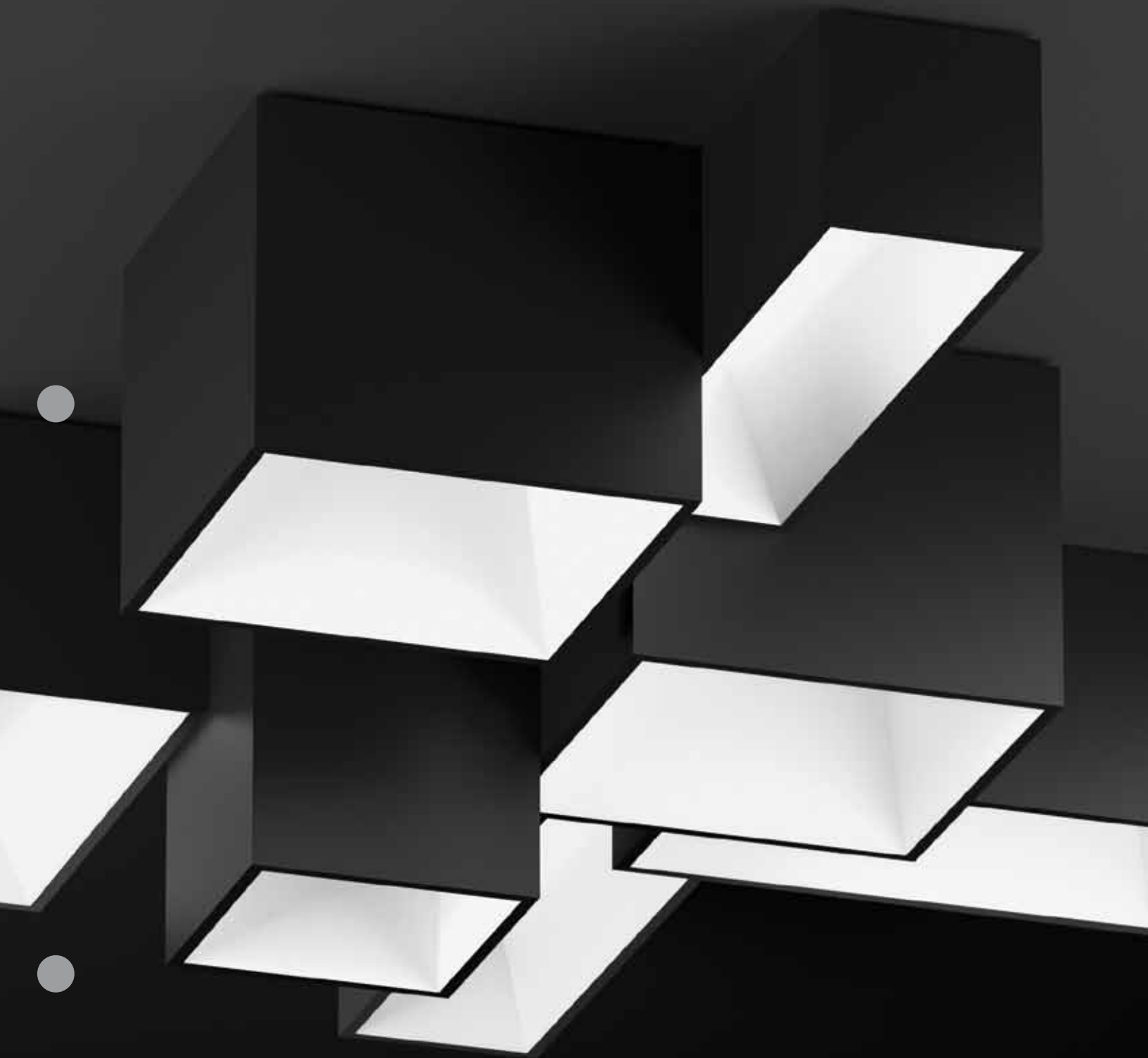

# Link...

## Architecture on the ceiling

Design by Ramón Esteve

Like the skyline of a great city... The modules of the Link lighting system allow you to create silhouettes and volumes on the ceiling to suit every room and every location.

Link consists of four modules in different sizes and heights, which connect to one another, to offer a wide range of geometries perfectly fitting into the architecture of the ceiling.

They only require one electrical connection for every eight sections per configuration and their light source is dimmable and efficient.



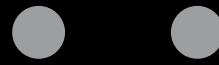
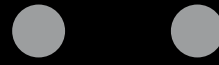
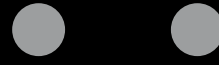

# Modular system on the ceiling

The four modules of the Link lighting system can be connected to one another on any of the four sides of each piece, making it possible to create arrangements and volumes to meet any requirement. Each surface mounted configuration only requires a single electrical connection in the ceiling for every eight sections per configuration.

5350.



5355.



5360.

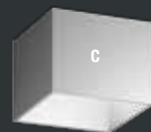

5365.



## Total: 3 shapes

- A - 1 piece ( 5350 ).
- B - 1 piece ( 5355 ).
- C - 1 piece ( 5360 ).

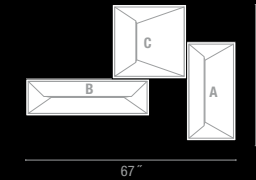
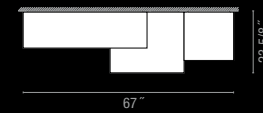
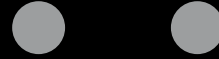
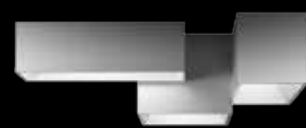

## Total: 4 shapes

- A - 1 piece ( 5350 ).
- B - 1 piece ( 5355 ).
- C - 1 piece ( 5360 ).
- D - 1 piece ( 5365 ).

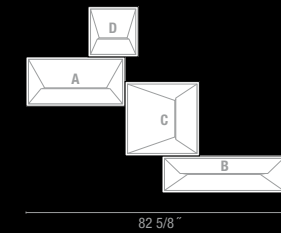
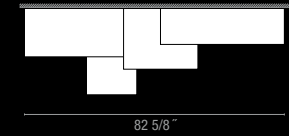
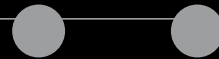
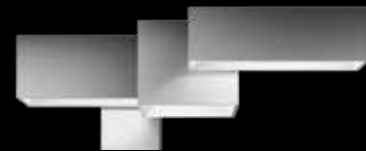

## Total: 6 shapes

- A - 2 pieces ( 5350 ).
- B - 2 pieces ( 5355 ).
- C - 1 piece ( 5360 ).
- D - 1 piece ( 5365 ).

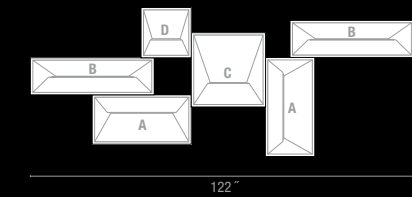
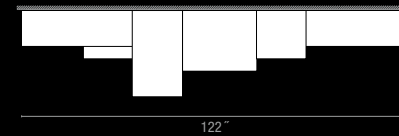
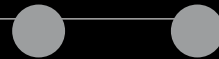
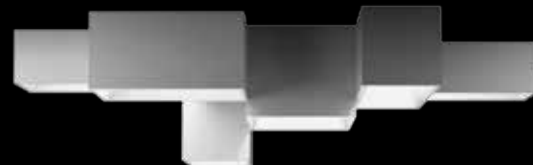

## Total: 8 shapes / 8 unidades

- A - 2 pieces ( 5350 ).
- B - 2 pieces ( 5355 ).
- C - 2 pieces ( 5360 ).
- D - 2 pieces ( 5365 ).

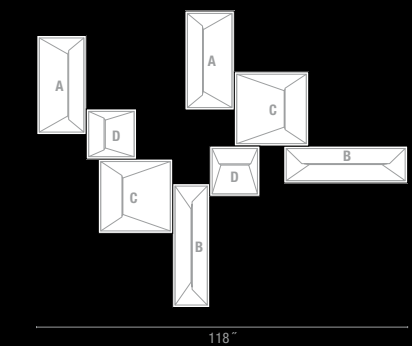
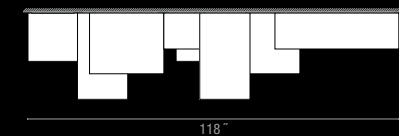
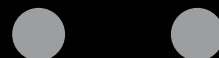
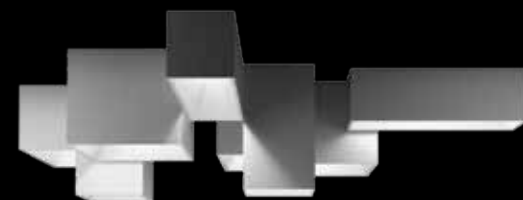

[www.vibialight.com](http://www.vibialight.com)

Visit [www.vibialight.com](http://www.vibialight.com) to download specification information including 2D/3D files and start your project today.

## A system made simple for connection and maintenance

The modules of the Link lighting system connect to one another on any of their four sides, requiring at least 5.5" of overlapping surface area. All the shapes are electrically connected to each other, so that a single electrical connection in the ceiling is enough for up to 8 modules.

Maintenance and lamp changes are made easy. The modules have a mounting system allowing each module to be easily raised or lowered granting access to the surface mounted lamps and electronic ballasts.

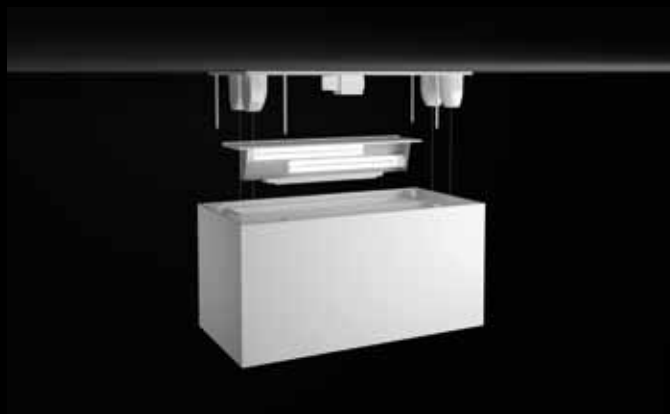
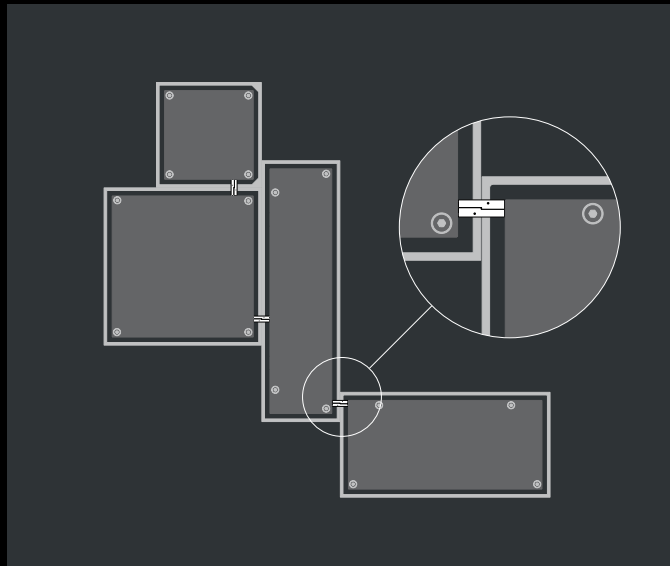

## Ambient lighting

Compositions with Link enable you to play with the trajectory of the light as it hits the different geometries of each cube, creating comfortable indirect ambient lighting.

Link is dimmable using 0-10V electronic dimming ballasts that can operate on a wide-range of dimming control systems, allowing for different degrees of brightness depending on the time of day and the atmosphere you wish to create.

The illumination from this lighting system is magical, giving the feeling of natural light as if the sun's rays were entering through the different volumes in the ceiling.

If needed, photometry is available by request at: [sales@vibialight.com](mailto:sales@vibialight.com)

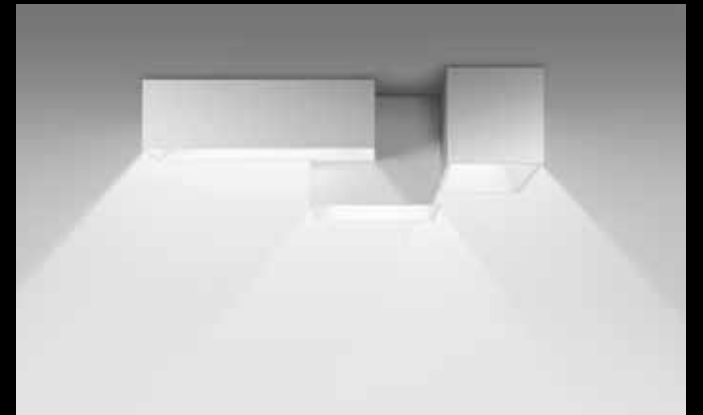
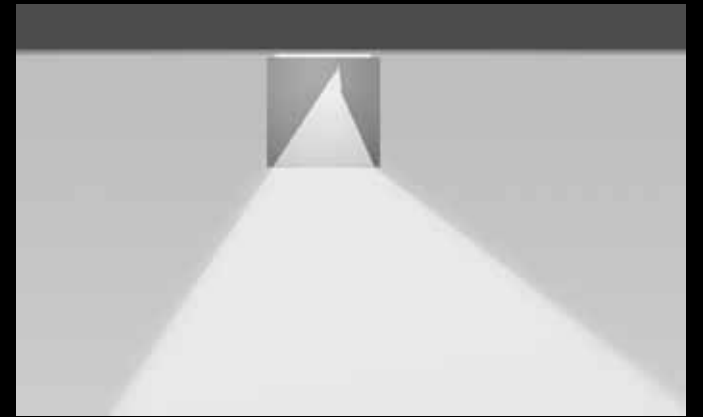

Polycarbonate diffuser.

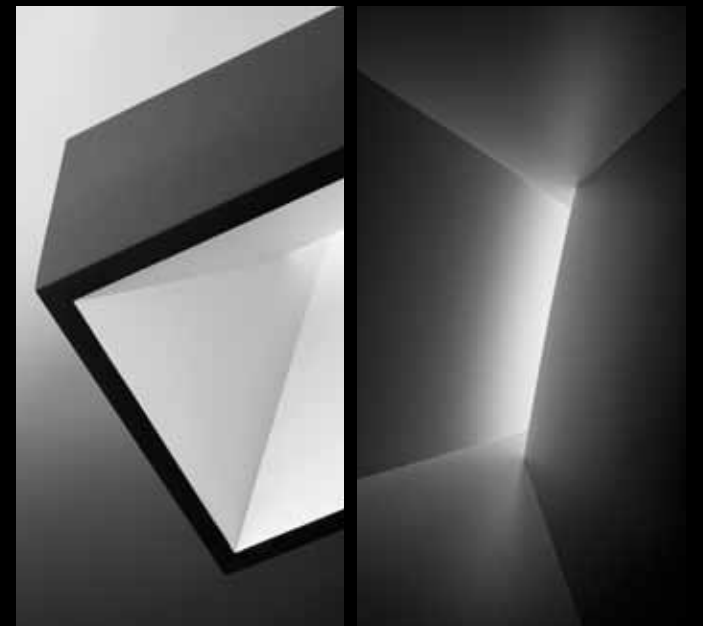

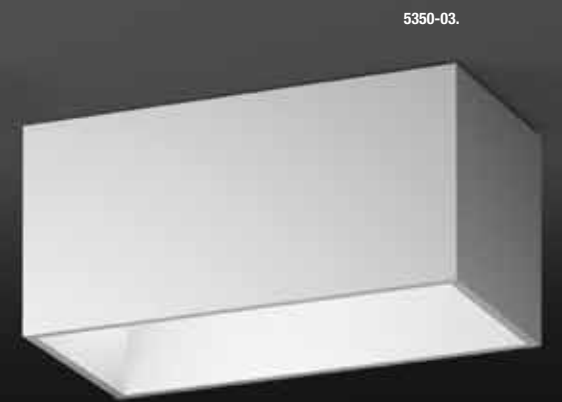
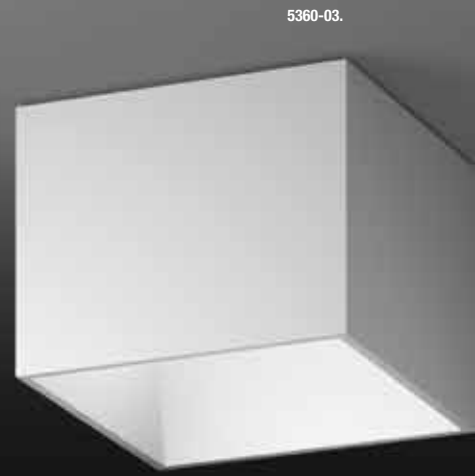

**Link**  
Design by Ramón Esteve.

Matte white lacquer and charcoal grey.  
Polycarbonate diffuser.

**5350.**

2 x 2G11 36W.

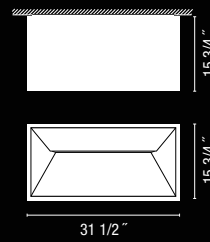

**5355.**

2 x 2G11 36W.

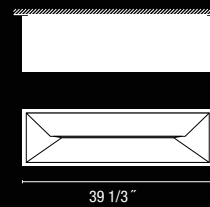

**5360.**

2 x 2G11 24W.

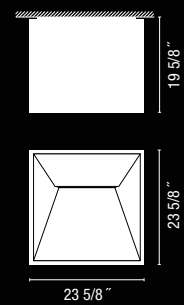

**5365.**

2 x 2G11 24W.

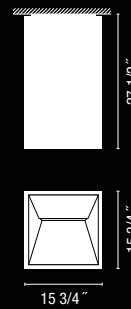

Dimmable 0-10V multi-volt  
electronic ballast 120-277V



5350-03 / 5355-03 /  
5360-03 / 5365-03.  
Matte white lacquer /

5350-18 / 5355-18 /  
5360-18 / 5365-18.  
Charcoal grey /







visit **www.vibialight.com**

to download specification and 2D/3D files.

Your imagination is the only limitation.

**USA & CANADA**

**VIBIA, INC.**

272 Fernwood Ave.  
Edison, NJ 08837. USA  
Phone 732 417 1700.  
Fax 732 417 1701.  
sales@vibialight.com  
www.vibialight.com

**HEADQUARTERS**

**GRUPO T DIFFUSION, S.A.**

Barcelona, 72 - 74. 08820 El Prat de Llobregat (Barcelona - Spain)

